

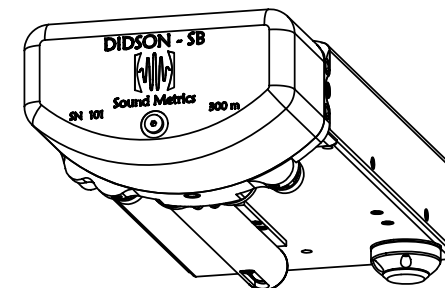

ACOUSTIC BEAM  
PROJECTIONS  
30° HORIZONTAL  
14° ELEVATION

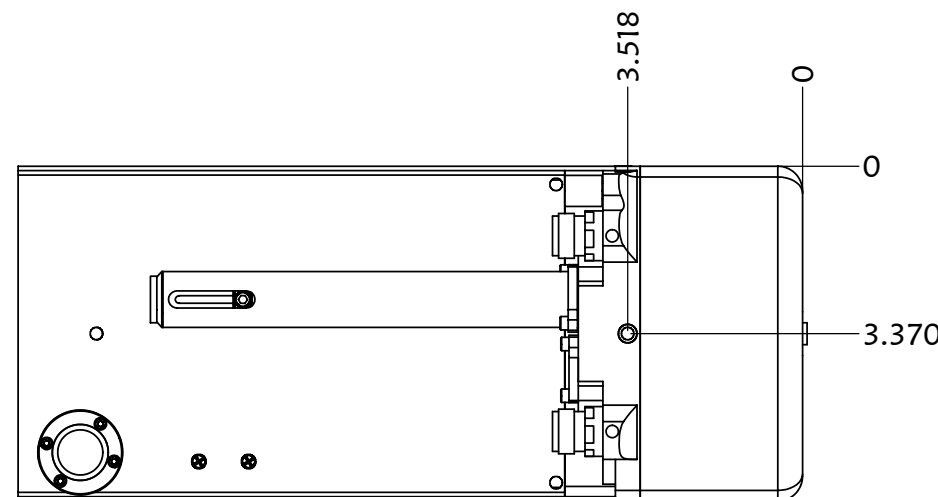
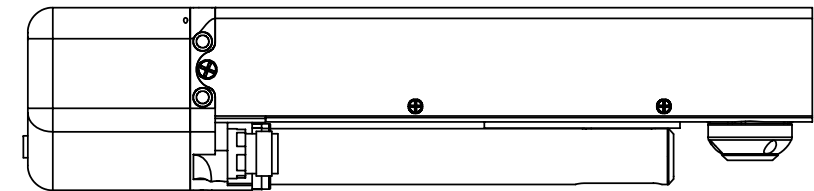
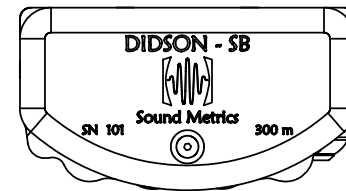
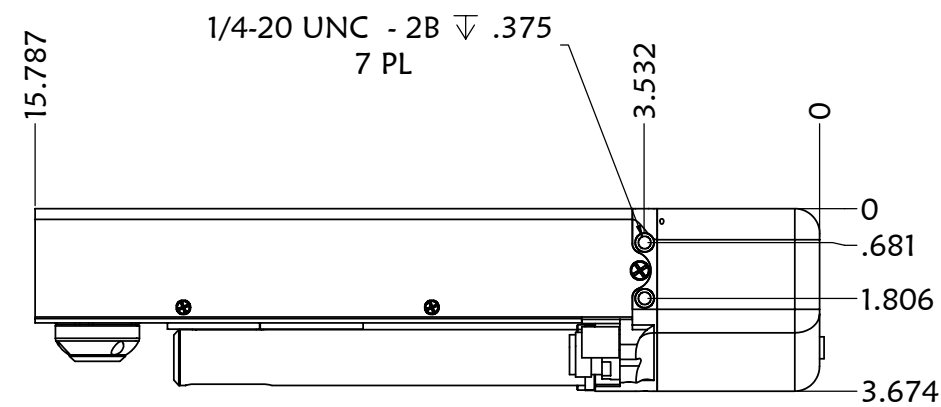
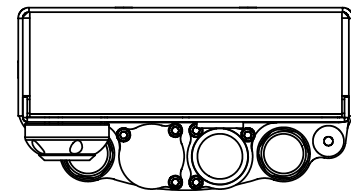

AIR WEIGHT: 4.9 Kg  
IN SALT WATER WEIGHT: 1.9 Kg

		<b>SOUND METRICS CORP</b> <small>USING SOUND TO MAKE SOUND MEASUREMENTS</small>	
<b>SONAR HEAD ASSEMBLY</b> 300m - STANDARD RANGE DIDSON SB			
SIZE E	DRAWING NUMBER <b>1015</b>	REV	
<small>ALL DIMENSIONS ARE IN INCHES.</small>		<small>PLOT DATE: 3/4/2005</small>	<small>SCALE: 1:1.25 SHEET 1 OF 1</small>